TABLE OF CONTENTS

Specifications	1-2
Quick Spec Guide	1-3
Elevations/Sizes: 1/4" Scale	
Full Casement	1-4
Full Impact Casement	1-6
Glazing Options: 3" Scale	1-7
Grille Patterns	1-8
Section Details: 6" Scale	1-9

PRODUCT SPECIFICATIONS

MATERIALS

The extruded vinyl profiles comply with the performance requirements of AAMA 303-97. Solid color extrusions are available in White and Desert Sand.

FRAME

All frames and sash are assembled using fusion-welding technology for added strength and durability. The frame jamb width is 3-1/4" (76.2mm), and the nominal extrusion exterior wall thickness is 0.070". The frame incorporates an integral nailing fin which can be easily removed to allow the unit to be used in a replacement window application. Weep holes are included on the sash to ensure standing water is directed to the exterior plane of the unit. An interior and exterior accessory groove is standard to accommodate various frame accessory and assembly options on the product. Optional frame types are: snap-in 5/8" flange, snap-in J-channel, snap-in Brickmould, and Box.

SASH

The casement sash is a 2-1/4" (57.15mm) nominal thickness and is assembled using fusion-welding technology for added strength and durability.

GLAZING

7/8" (22.2mm) insulated glass consists of two lites of glass sealed around a spacer; 3/4" (19mm) insulated glass for SDL units. The glass is mounted into the sash using a silicone-glazing compound. The insulating glass units comply with the performance requirements of the IGCC in accordance with either ASTM E774 or E2190. All units are exterior glazed.

GLAZING OPTIONS

7/8" (22.2mm) or 3/4" (19mm) insulated glass is available in clear, Low-E or Low-E 366, tinted, obscure or other specialty insulating glass as specified. Many glass options are available in tempered glazing, ImpactGard®, or monolithic glass.

WEATHER-STRIPPING

A fin-pile and a v-shaped compression weather-strip is applied along the perimeter of the operating sash. A v-shaped compression weather-strip is applied along the perimeter of the frame.

HARDWARE

The concealed multi-point lock provides exceptional ease of use with the single actuating handle. The casement operator uses a corrosion resistant dual arm operator to ensure maximum performance. Narrower casement units may use a single arm dyad operator. Handing is available in left/right hand hinges as viewed from outside and as a stationary unit (for impact products). An upgraded coastal package is available.

INSECT SCREENS

The interior fiberglass charcoal color insect screen is set in an aluminum frame to match the color of the unit. The screen is secured to the window using a decorative swivel clip system. Insect screens are intended to allow air and light in and keep insects out. They are not intended to keep anyone or anything from falling through an open door or window. For safety screens or other security devices contact your local building supply retailer

GRILLES

SDL (Simulated Divided Lite) 1" (25.4mm) color-matched extruded aluminum contour muntins surface mounted on the exterior surfaces of the insulated glass unit to provide a true divided lite appearance.

GBG (Grilles between the Glass) - 5/8" (16mm) or 7/8" (22.2mm) flat or 5/8" (16mm) contour grilles mounted between the glass panes suspended within the air cavity and color matched to the extrusion color.

EXTENSION JAMBS

Extension jambs are regionally available for JELD-WEN vinyl products. The 4-9/16" and 6-9/16" extension jambs are available in primed finger-joint and clear pine.

ADDITIONAL ACCESSORIES

Additional accessories are available for JELD-WEN Vinyl products. Please contact your local building supply retailer for a complete listing of the additional accessories. See www.jeld-wen.com/findsupplier.

INSTALLATION

See www.jeld-wen.com/resources for instructions.

PERFORMANCE

NFRC Certified - (rated and labeled in accordance with NFRC)

AAMA/NWDMA I.S.2-97

Please reference www.jeld-wen.com/performance for up to date Design Pressure and approval information.

QUICK SPEC GUIDE

SPECIFICATION	STANDARD FEATURES	OPTIONAL FEATURES <i>Some options may require additional lead times. Consult your JELD-WEN Sales Representative.</i>
COLOR	<ul style="list-style-type: none"> White 	<ul style="list-style-type: none"> Desert Sand
SIZE	<ul style="list-style-type: none"> Width: 23-1/2" - 35-3/4" Height: 25" - 71-1/2" 	
FRAME	<ul style="list-style-type: none"> Nail Fin 	<ul style="list-style-type: none"> J-Channel Box Frame Brickmould 5/8" Flange 2-3/8" Flange Extender
GLAZING	<ul style="list-style-type: none"> 7/8" Insulated Clear 	<ul style="list-style-type: none"> Tempered Low-E Bronze Gray Green Obscure Azurlite Graylite (Turtle) Bronze Reflective
IMPACTGARD PROTECTION		<ul style="list-style-type: none"> PVB Impact PVB Impact Insulated SGP Impact Single-Glaze SGP Impact Standard Insulated SGP Impact ImpactGard Insulated <p style="text-align: center;"><i>Not available in tempered. PVB monolithic not available in Low-E. All other tint and obscure glazing options apply.</i></p>
HARDWARE	<ul style="list-style-type: none"> Folding Handle 	<ul style="list-style-type: none"> Coastal Hardware Package
HARDWARE COLOR	<ul style="list-style-type: none"> Matches Frame 	
SCREENS	<ul style="list-style-type: none"> Fiberglass 	
SCREEN FRAME COLOR	<ul style="list-style-type: none"> Matches Frame 	
GRILLES		<ul style="list-style-type: none"> SDL - 1" Simulated Divided Lite 5/8", 7/8" Flat GBG* 5/8" Contour <p style="text-align: center;"><i>*Check for availability</i></p>
JAMB	<ul style="list-style-type: none"> 3-1/4" 	

FULL CASEMENT UNITS

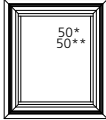
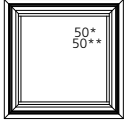
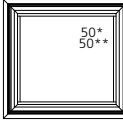
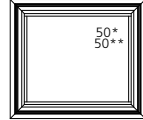
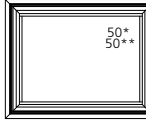
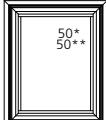
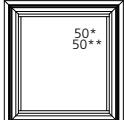
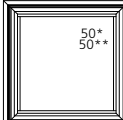
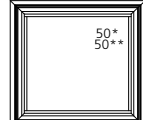
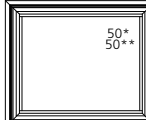
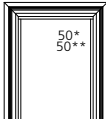
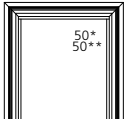
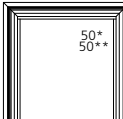
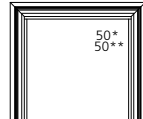
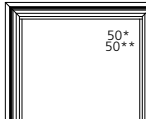
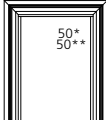
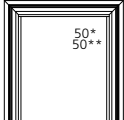
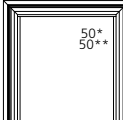
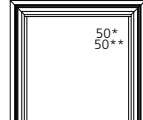
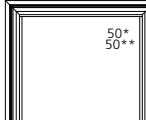
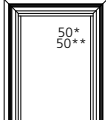
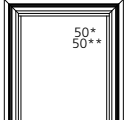
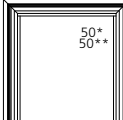
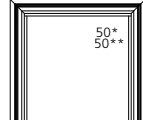
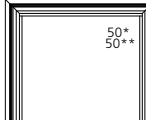
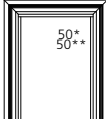
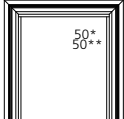
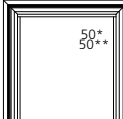
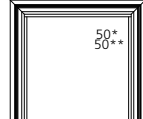
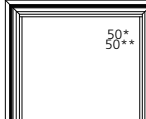
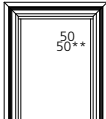
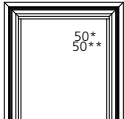
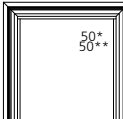
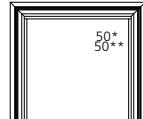
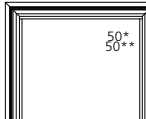









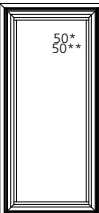
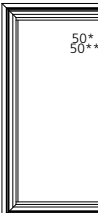

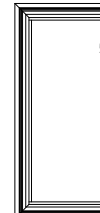
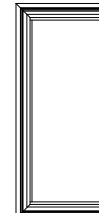
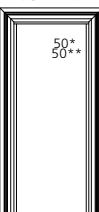



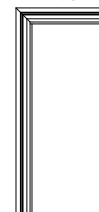
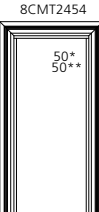

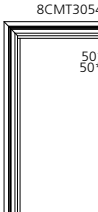

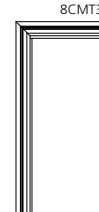
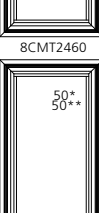
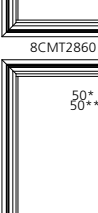
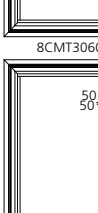

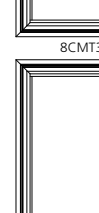
UNIT SIZE	26"(660)	30"(762)	32"(813)	34"(864)	38"(965)
ROUGH OPENING	24"(610)	28"(711)	30"(762)	32"(813)	36"(914)
FRAME SIZE	23 1/2"(597)	27 1/2"(699)	29 1/2"(749)	31 1/2"(800)	35 1/2"(902)
DAYLIGHT OPENING	17"(432)	21"(533)	23"(584)	25"(635)	29"(737)
30"(762) 28"(711) 27 1/2"(699) 21"(533)	 8CMT2428	 8CMT2828	 8CMT3028	 8CMT3228	 8CMT3628
32"(813) 30"(762) 29 1/2"(749) 22"(559)	 8CMT2430	 8CMT2830	 8CMT3030	 8CMT3230	 8CMT3630
38"(965) 36"(914) 35 1/2"(902) 29"(737)	 8CMT2436	 8CMT2836	 8CMT3036	 8CMT3236	 8CMT3636
40"(1016) 38"(965) 37 1/2"(953) 31"(787)	 8CMT2438	 8CMT2838	 8CMT3038	 8CMT3238	 8CMT3638
44"(1118) 42"(1067) 41 1/2"(1054) 35"(889)	 8CMT2442	 8CMT2842	 8CMT3042	 8CMT3242	 8CMT3642
46"(1168) 44"(1118) 43 1/2"(1105) 37"(940)	 8CMT2444	 8CMT2844	 8CMT3044	 8CMT3244	 8CMT3644 E
50"(1270) 48"(1219) 47 1/2"(1207) 41"(1041)	 8CMT2448	 8CMT2848	 8CMT3048	 8CMT3248	 8CMT3648 E

ELEVATION SYMBOL LEGEND:

VALUES IN () ARE IN MILLIMETER CONVERSIONS.
 ### NUMBER INDICATES DESIGN PRESSURE (DP) RATING WITH STANDARD GLAZING.
 #### NUMBER INDICATES OPTIONAL DESIGN PRESSURE (DP) RATING.
 E UNIT MEETS EGRESS REQUIREMENTS FOR IRC CODE. STATE AND LOCAL EGRESS CODES MAY DIFFER. ALWAYS REFER TO LOCAL BUILDING CODES FOR COMPLETE REQUIREMENTS. CHECK WITH LOCAL OFFICIALS TO ENSURE COMPLIANCE BEFORE INSTALLING THE UNIT.

SCALE: 1/4" = 1'

FULL CASEMENT UNITS

UNIT SIZE ROUGH OPENING FRAME SIZE DAYLIGHT OPENING	26" (660) 24" (610) 23 1/2" (597) 17" (432)	30" (762) 28" (711) 27 1/2" (699) 21" (533)	32" (813) 30" (762) 29 1/2" (749) 23" (584)	34" (864) 32" (813) 31 1/2" (800) 25" (635)	38" (965) 36" (914) 35 1/2" (902) 29" (737)
54" (1372) 52" (1321) 51 1/2" (1308) 45" (1143)	 50* 50**	 50* 50**	 50* 50**	 50* 50**	 50* 50** E
56" (1422) 54" (1372) 53 1/2" (1359) 47" (1194)	 50* 50**	 50* 50**	 50* 50**	 50* 50**	 50* 50** E
62" (1575) 60" (1524) 59 1/2" (1511) 53" (1346)	 50* 50**	 50* 50**	 50* 50**	 50* 50**	 50* 50** E
64" (1626) 62" (1575) 61 1/2" (1562) 55" (1397)	 50* 50**	 50* 50**	 50* 50**	 50* 50**	 50* 50** E
68" (1727) 66" (1676) 65 1/2" (1664) 59" (1499)	 50* 50**	 50* 50**	 50* 50**	 50* 50**	 50* 50** E
74" (1880) 72" (1829) 71 1/2" (1861) 65" (1651)	 50* 50**	 50* 50**	 50* 50**	 50* 50**	 50* 50** E

ELEVATION SYMBOL LEGEND:

VALUES IN () ARE IN MILLIMETER CONVERSIONS.

*** NUMBER INDICATES DESIGN PRESSURE (DP) RATING WITH STANDARD GLAZING.

**** NUMBER INDICATES OPTIONAL DESIGN PRESSURE (DP) RATING.

E UNIT MEETS EGRESS REQUIREMENTS FOR IRC CODE. STATE AND LOCAL EGRESS CODES MAY DIFFER. ALWAYS REFER TO LOCAL BUILDING CODES FOR COMPLETE REQUIREMENTS. CHECK WITH LOCAL OFFICIALS TO ENSURE COMPLIANCE BEFORE INSTALLING THE UNIT.

SCALE: 1/4" = 1'

FULL IMPACT CASEMENT UNITS
FLORIDA SIZES

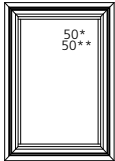
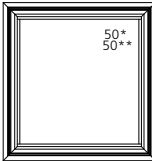
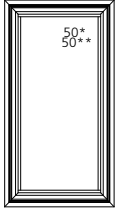
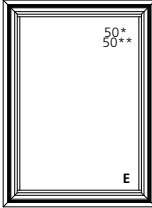
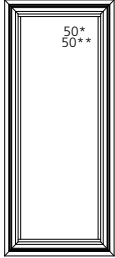
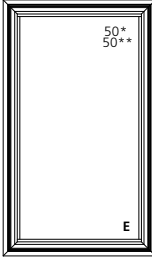
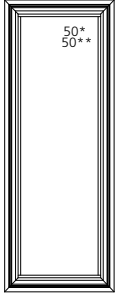
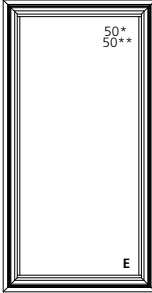
UNIT SIZE	27 3/4" (705)	38 1/4" (972)
ROUGH OPENING	25 3/4" (654)	36 1/4" (921)
FRAME SIZE	25 1/4" (641)	35 3/4" (908)
DAYLIGHT OPENING	18 3/4" (476)	29 1/4" (743)
39 5/8" (1006) 37 5/8" (956) 37 1/8" (943) 30 3/8" (778)		
	8CMT-H33	8CMT-23
51 7/8" (1318) 48 7/8" (1267) 45 5/8" (1234) 42 7/8" (1089)		
	8CMT-H34	8CMT-24
64 1/4" (1632) 62 1/4" (1581) 61 3/4" (1568) 55 1/4" (1403)		
	8CMT-H35	8CMT-25
73 1/4" (1861) 71 1/4" (1810) 70 3/4" (1797) 64 1/4" (1632)		
	8CMT-H36S	8CMT-26S

ELEVATION SYMBOL LEGEND:

VALUES IN () ARE IN MILLIMETER CONVERSIONS.

##* NUMBER INDICATES DESIGN PRESSURE (DP) RATING WITH STANDARD GLAZING.

####* NUMBER INDICATES OPTIONAL DESIGN PRESSURE (DP) RATING.

E UNIT MEETS EGRESS REQUIREMENTS FOR IRC CODE. STATE AND LOCAL EGRESS CODES MAY DIFFER. ALWAYS REFER TO LOCAL BUILDING CODES FOR COMPLETE REQUIREMENTS. CHECK WITH LOCAL OFFICIALS TO ENSURE COMPLIANCE BEFORE INSTALLING THE UNIT.

SCALE: 1/4" = 1'

GLAZING OPTIONS

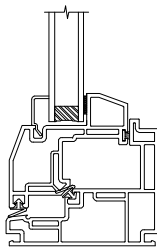

3/4" IG
1/8" GLASS SIZE

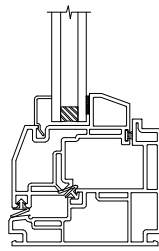

3/4" IG
3/16" GLASS SIZE

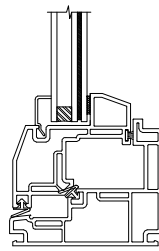

3/4" LAMINATED GLASS
1/8" GLASS SIZE

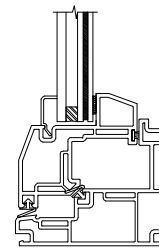

3/4" LAMINATED GLASS
3/16" GLASS SIZE

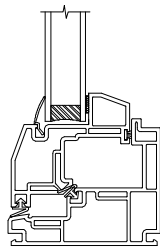

7/8" IG
1/8" GLASS SIZE

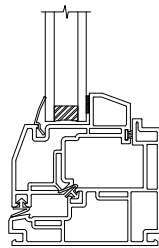

7/8" IG
3/16" GLASS SIZE

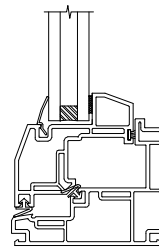

7/8" IG
1/4" GLASS SIZE

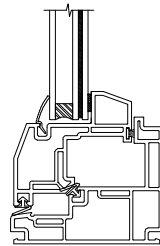

7/8" IMPACT GLASS
1/8" GLASS SIZE

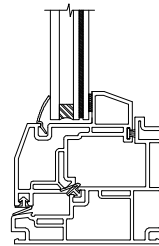

7/8" IMPACT GLASS
3/16" GLASS SIZE

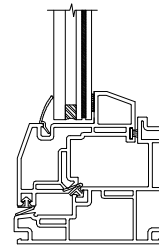

7/8" IMPACT GLASS
1/4" GLASS SIZE

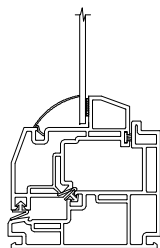

SINGLE GLAZED
1/8" GLASS SIZE

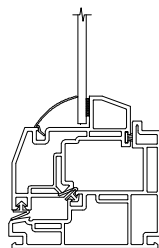

SINGLE GLAZED
3/16" GLASS SIZE

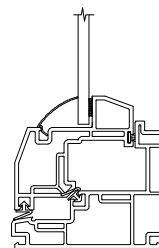

SINGLE GLAZED
1/4" GLASS SIZE

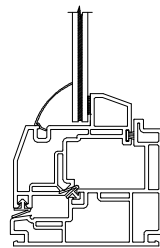

SINGLE GLAZED IMPACT
1/8" GLASS SIZE

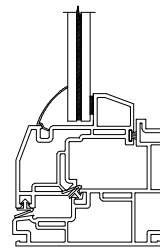

SINGLE GLAZED IMPACT
3/16" GLASS SIZE

SCALE: 3" = 1'

GRILLES PATTERNS

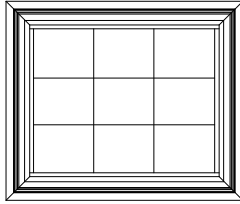

STANDARD

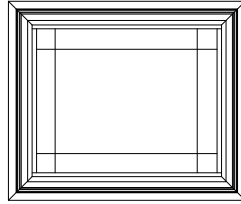

PRAIRIE

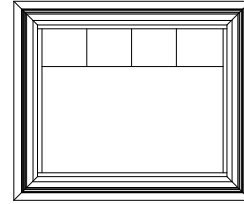

COLONIAL TOP 1/2

CASEMENT UNIT
NAIL FIN

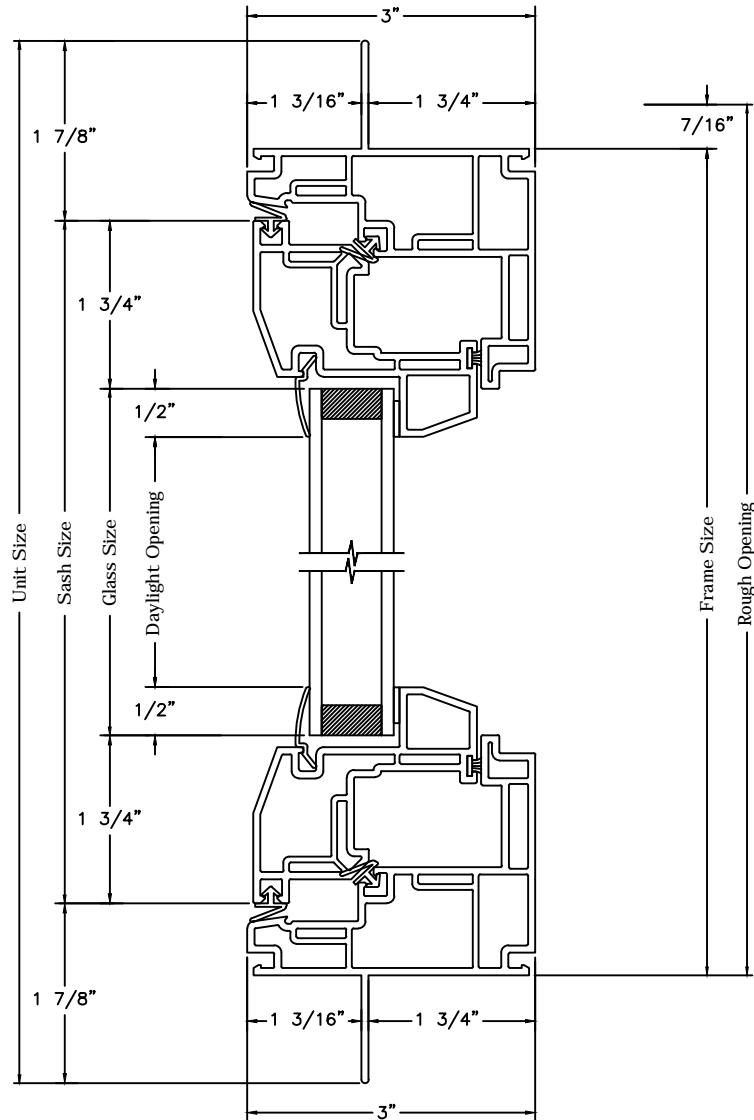

Vertical Section

CASEMENT UNIT
NAIL FIN

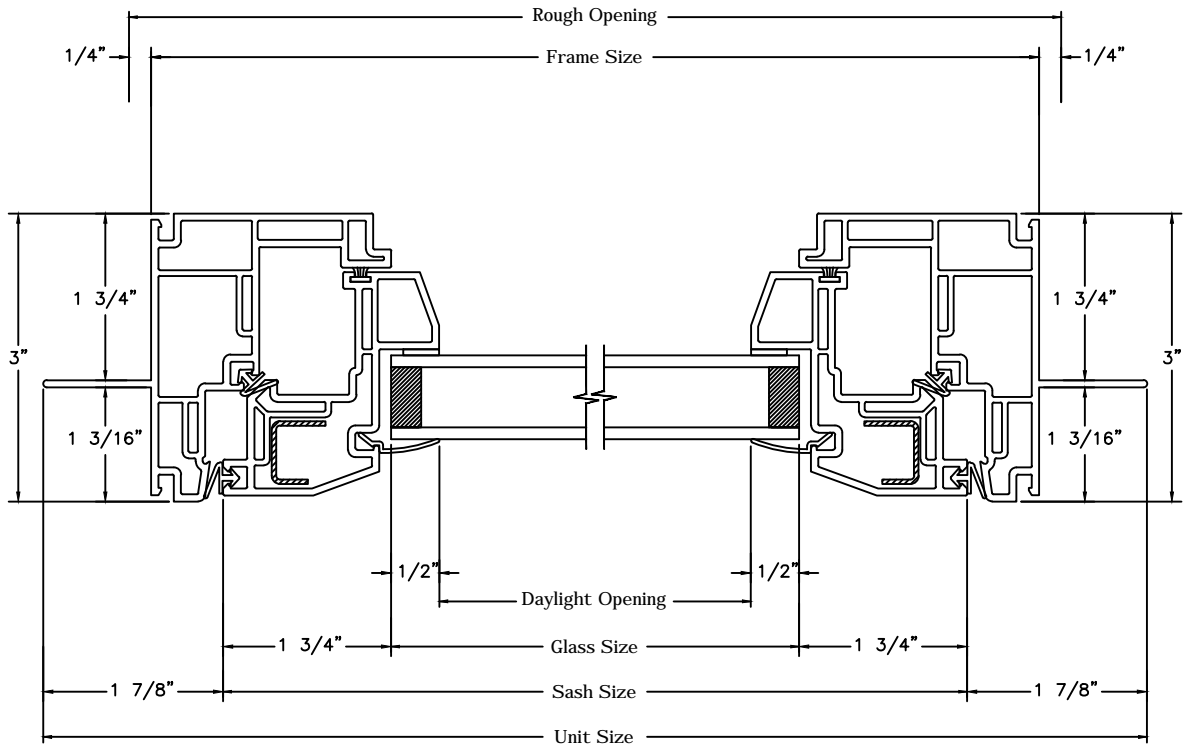

Horizontal Section

CASEMENT UNIT
FLANGE

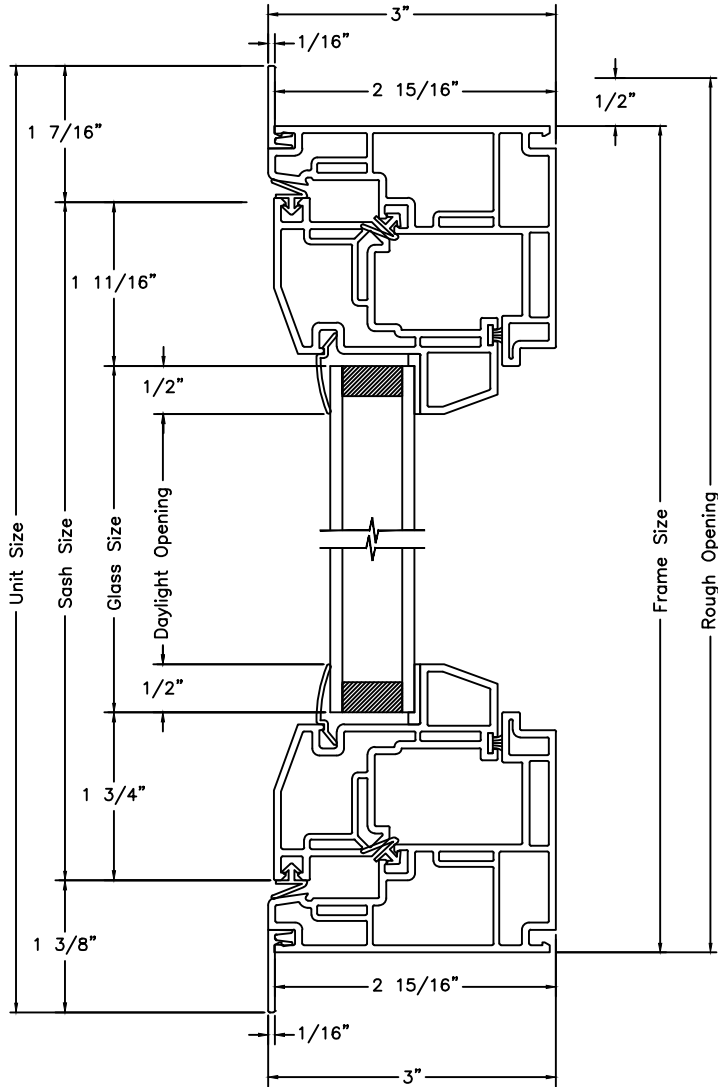

Vertical Section

CASEMENT UNIT
FLANGE

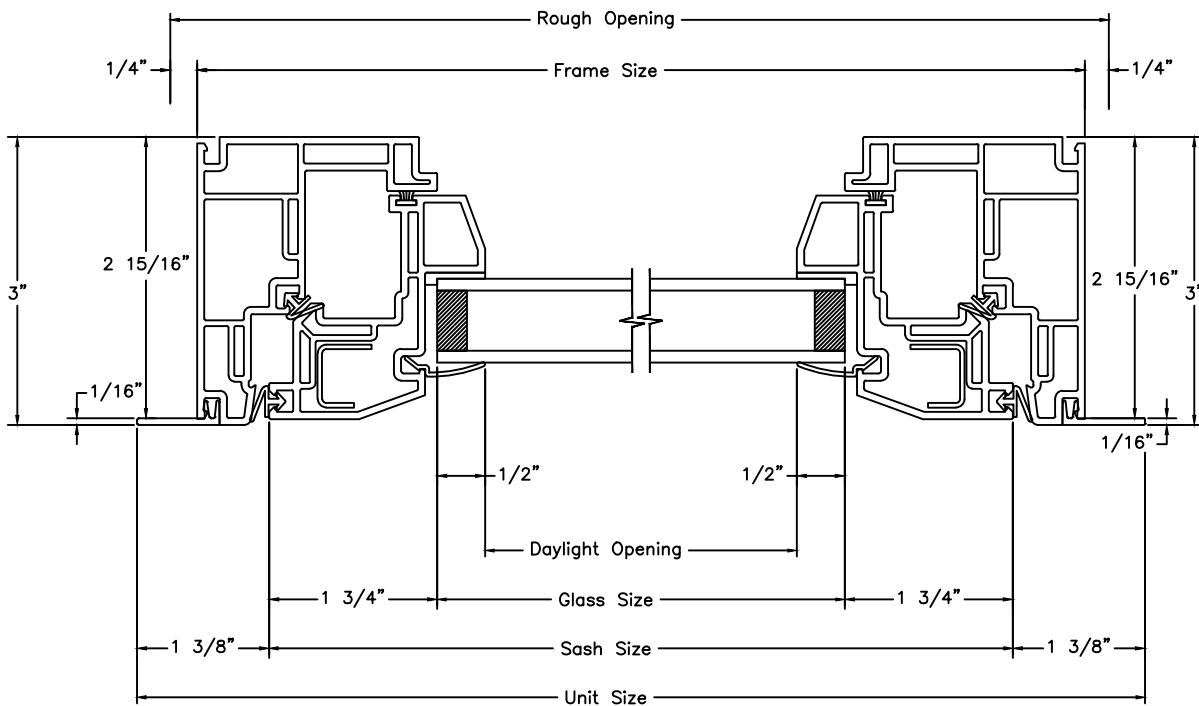

Horizontal Section

CASEMENT UNIT
POCKET

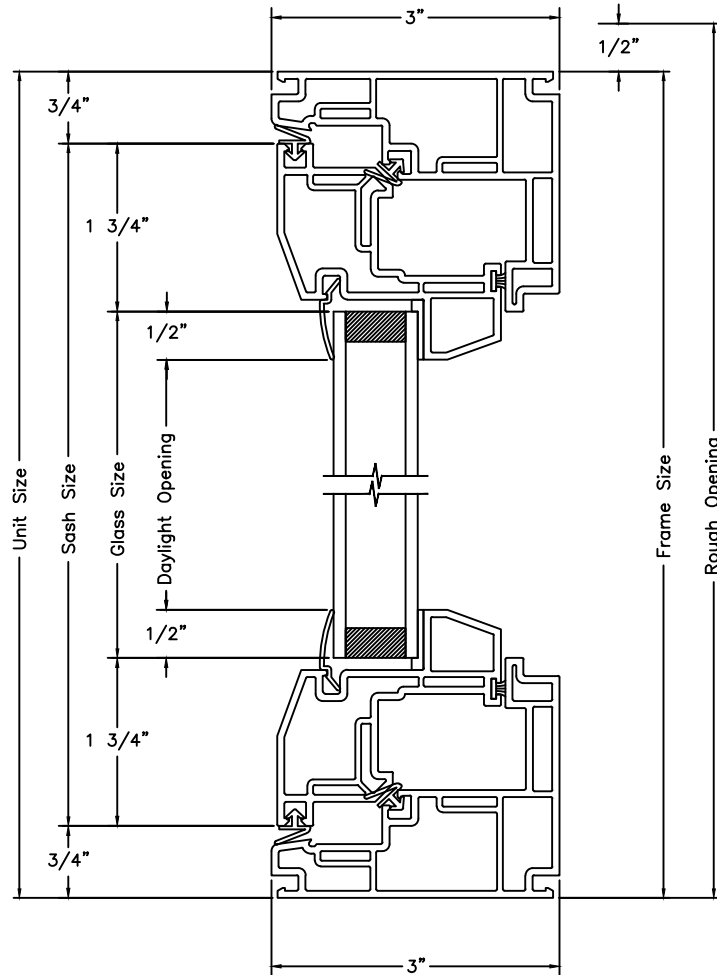

Vertical Section

